

LIST PRICING &  
PRODUCT SPECIFICATIONS  
Effective July 2023



WOLF HOME PRODUCTS®

CABINETS

WOLF CLASSIC™

# HARMONY SERIES



## WOLF CLASSIC

Wolf Classic provides the right cabinetry for every project and budget. Today's most popular door styles, carefully curated finishes and practical storage solutions make your designs an affordable and beautiful reality. Add in a wide selection of SKUs, accessories, and mouldings for even greater design flexibility. Wolf Classic cabinets are hand-crafted, built with solid hardwood components and expertly finished for a beautiful and long-lasting appearance. And they're backed by our industry-leading five-year warranty for peace of mind. With Wolf Classic, you'll enjoy the ideal combination of quality and value.

### **HARMONY SERIES:**

Quality finish with strong construction

- Limited offering of door styles and finishes
- Quick Ship SKUs
- Unique special order SKUs—not offered in other series

## CABINET SPECIFICATIONS

<b>Face Frame</b>	3/4" thick x 1 1/2" wide solid birch face frame
<b>Side Panels</b>	1/2" thick UV coated plywood with color matching exterior
<b>Back Panel</b>	1/2" thick UV coated plywood
<b>Top/Bottom</b>	1/2" thick UV coated plywood
<b>Interior</b>	UV coated, natural birch interior
<b>Shelves</b>	3/4" thick veneered plywood, adjustable, with shelf pins
	Half-depth, adjustable base
<b>Corner Blocks</b>	All-wood
<b>Hanging Rail</b>	1/2" thick - Horizontal
<b>Drawers</b>	5/8" thick solid wood, clear finished
	Dovetail - 4" high
	1/4" thick plywood bottom
<b>Glides</b>	Soft Close, full extension undermount 100 lb. weight capacity
<b>Hinges</b>	Soft Close, 6-way adjustable

## CABINET REVEALS

### Full Overlay

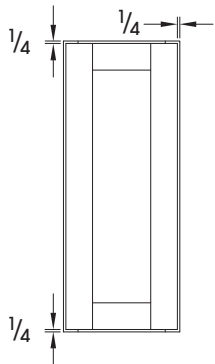

Wall

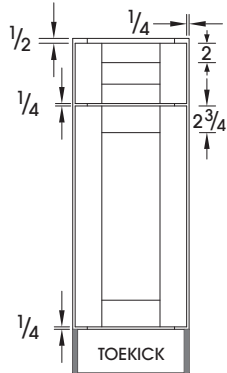

Base

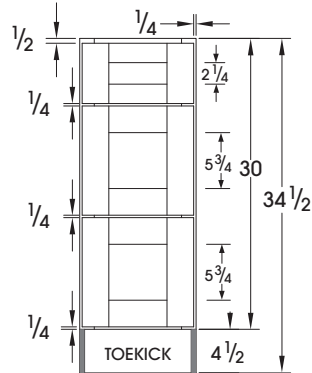

3 Drawer Base

## DOOR STYLES

### CAMERON

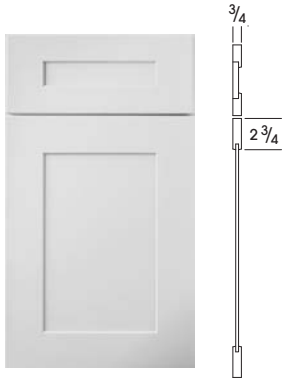

- **Full Overlay**
- 5-piece Flat Panel Drawer Front
- Flat Panel Shaker Door
- HDF with HDF Center Panel

Standard Finish	Code
Diamond Paint	401
Shale Paint	402

## WOOD CHARACTERISTICS & VARIATIONS

Naturally occurring wood characteristics such as variations in color, grain, mineral streaks and knots are not considered defects.

Color variations are a natural occurrence due to species, age, character of cabinets, and exposure to UV light and sunlight. Such variations and changes are not considered defects. For these reasons, new and/or replacement cabinets may not match display samples and/or existing cabinets.

Warping is the bending or twisting of a part. To measure a door or shelf, lay the product on a flat surface and measure the gap from the surface to the part. The standard allowable tolerance for wood is 1/8" per lineal foot. Materials that fall within specification are considered acceptable, as a part of the natural characteristics of wood.

Using High Density Fiberboard provides a smooth, painted surface that does not expand or contract and reduces visible seams where pieces are joined. Fiberboard also provides a stable substrate that minimizes warping and provides better moisture resistance – an industry standard material for painted product.

## FINISH PROCESS

1. The finest wood components are sanded with precision
2. A balanced base coat is applied to ensure a consistent, quality finish
3. First stage ultraviolet (UV) curing process occurs
4. The wood is finely sanded and vacuumed
5. A tinted primer is applied as a foundation for our superior finish
6. Second stage (UV) curing
7. The wood is finely sanded and vacuumed
8. The solid paint layer is evenly applied
9. Third stage (UV) curing
10. The wood is finely sanded and vacuumed
11. First layer of water based clear coat is applied
12. The components go through the dryer to prepare for final processing
13. The wood is finely sanded and vacuumed
14. Second layer of water-based clear coat is applied
15. The components go through the dryer once again
16. Final sanding for a smooth surface and vacuumed for a thorough cleaning
17. A final layer of topcoat is evenly applied
18. Oven cured for catalyzed hardened finish
19. Visual inspection with a color consistency examination performed

## NOMENCLATURE

B = Base	LGCROWN = Large Crown	SSMCROWN = Small Crown for Full Overlay
B_FH = Base with Full Height Door	MBAT = Batten	STCROWN = 2-Pc. Starter Crown
BC = Base Corner	MICW = Inside Corner	TFOOT = Tapered Foot
BER = Base Easy Reach	MLR = Light Rail	TFOOTHALF = Half Tapered Foot
BFOOT = Bun Foot	MOCW = Outside Corner	TSKIN = Tall Skin
BFOOTHALF = Half Bun Foot	MQR = Quarter Round	U = Utility
BMW = Base Microwave Cabinet	MSHOE = Shoe	V = Valance
BP = Beaded Panel	MSW = Scribe	VB = Vanity Base
BSKIN = Base Skin	MWC = Microwave Cabinet	VDB = Vanity Drawer Base
BWB = Base Waste Basket	OC = Oven Cabinet	VDT = Vanity Drawer Tray
CCROWN = Cove Crown	ORG = Organizer	VSB = Vanity Sink Base
CORBEL = Corbel	P = Panel	VSDB = Vanity Sink Drawer Base
DB_D2 = Drawer Base, 2 Drawers	POCD = Double Oven Panel Overlay	W = Wall
DB_D3 = Drawer Base, 3 Drawers	POS = Pull-out Shelf	WC = Wall Corner
DD = Double Door	POSSC = Pull-out Shelf - Soft Close	WDC = Wall Diagonal Cabinet
DEP = Decorative End Panel	PR = Plate Rack	WEC = Wall End Cabinet
DEPB = Decorative End Panel Base	REFP = Refrigerator Panel	WF = Wall Filler
DWEP = Decorative Wall End Panel	REVCROWN = Reversible Crown	WMD = Wall Mullion Door (Doors with Glass)
DWP = Dishwasher End Panel	ROINSTKIT = Roll-out Install Kit	WMDC = Wall Mullion Diagonal Cabinet (Doors with Glass)
F = Filler	RW = Refrigerator Wall	WR = Wine Rack
FB = Furniture Base	SB = Sink Base	WSKIN = Wall Skin
FSB = Farm Sink Base	SCBFF = Sink Front Diagonal w/Floor	
LC = Linen Cabinet	SLGCROWN = Large Crown for Full Overlay	
LEG = Leg	SMCROWN = Small Crown	<b>B12 = Base 12" Wide</b>
LEGHALF = Half Leg	SS = Super Lazy Susan	<b>W3030 = Wall 30" Wide, 30" High</b>

Wall Cabinets – 12" Deep

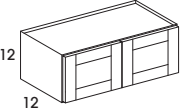
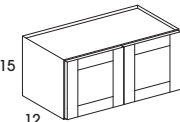
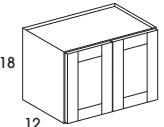
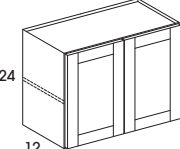
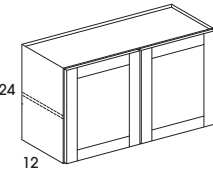
		SKU	cubes	Standard Price
<b>WALL - 12" HIGH - 12" DEEP</b>				
 <p>12 12</p> <ul style="list-style-type: none"> <li>• Two butt doors</li> <li>• Shelves not available</li> <li>• Available widths: 30"-36"</li> </ul>	W3012	3.0	286	
	W3312	3.3	294	
	W3612	3.5	309	
<b>WALL - 15" HIGH - 12" DEEP</b>				
 <p>15 12</p> <ul style="list-style-type: none"> <li>• Two butt doors</li> <li>• Shelves not available</li> <li>• Available widths: 30"-36"</li> </ul>	W3015	3.5	312	
	W3315	4.0	316	
	W3615	4.5	325	
<b>WALL - 18" HIGH - 12" DEEP</b>				
 <p>18 12</p> <ul style="list-style-type: none"> <li>• Two butt doors</li> <li>• Shelves not available</li> <li>• Available widths: 24"-36"</li> </ul>	W2418DD	3.5	320	
	W3018	4.5	325	
	W3318	4.7	340	
	W3618	5.0	361	
<b>WALL - 24" HIGH - 12" DEEP</b>				
 <p>24 12</p> <ul style="list-style-type: none"> <li>• Two butt doors</li> <li>• One adjustable shelf</li> <li>• Available widths: 30"-36"</li> </ul>	W3024	5.5	524	
	W3324	6.0	543	
	W3624	6.5	613	
 <p>24 12</p> <ul style="list-style-type: none"> <li>• Two doors, cabinet with center stile</li> <li>• One adjustable shelf</li> <li>• Available width: 39"</li> </ul>	W3924	7.5	686	

Wall Cabinets – 12" Deep

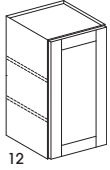
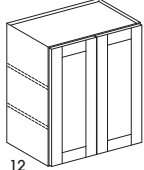
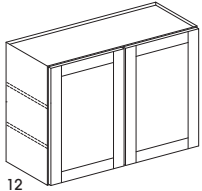
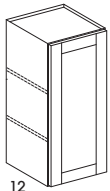
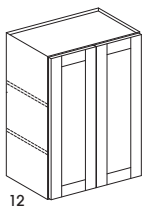
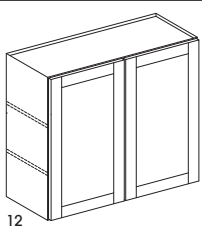
Design Tips:		SKU	depth	Standard Price
<ul style="list-style-type: none"> <li>All single-door cabinets are hinged left</li> <li>Cabinets can be flipped during installation for right hinge applications</li> </ul>				
<b>WALL – 30" HIGH – 12" DEEP</b>				
 <p>30 12</p>	<ul style="list-style-type: none"> <li>Single door</li> <li>Two adjustable shelves</li> <li>Available widths: 9"-21"</li> </ul>	W0930	2.5	252
		W1230	3.0	302
		W1530	3.5	309
		W1830	4.5	325
		W2130	5.0	371
 <p>30 12</p>	<ul style="list-style-type: none"> <li>Two butt doors</li> <li>Two adjustable shelves</li> <li>Available widths: 24"-36"</li> </ul>	W2430DD	5.5	463
		W2730	6.5	482
		W3030	7.0	515
		W3330	7.5	534
		W3630	8.5	609
 <p>30 12</p>	<ul style="list-style-type: none"> <li>Two doors, cabinet with center stile</li> <li>Two adjustable shelves</li> <li>Available widths: 39" and 42"</li> </ul>	W3930	9.0	629
		W4230	9.5	645
<b>WALL – 36" HIGH – 12" DEEP</b>				
 <p>36 12</p>	<ul style="list-style-type: none"> <li>Single door</li> <li>Two adjustable shelves</li> <li>Available widths: 9"-21"</li> </ul>	W0936	2.5	268
		W1236	3.5	309
		W1536	4.5	351
		W1836	5.0	396
		W2136	6.0	439
 <p>36 12</p>	<ul style="list-style-type: none"> <li>Two butt doors</li> <li>Two adjustable shelves</li> <li>Available widths: 24"-36"</li> </ul>	W2436DD	6.5	520
		W2736	7.5	541
		W3036	8.5	567
		W3336	9.0	609
		W3636	10.0	653
 <p>36 12</p>	<ul style="list-style-type: none"> <li>Two doors, cabinet with center stile</li> <li>Two adjustable shelves</li> <li>Available width: 42"</li> </ul>	W4236	11.5	755



Wall Cabinets – 12" Deep

Design Tips:

- All single-door cabinets are hinged left
- Cabinets can be ipped during installation for right hinge applications

SKU

cubes

Standard Price

WALL - 42" HIGH - 12" DEEP

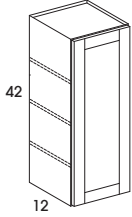

- Single door
- Three adjustable shelves
- Available widths: 9"-21"

W0942

3.0

302

W1242

4.0

361

W1542

5.0

396

W1842

6.0

439

W2142

7.0

472

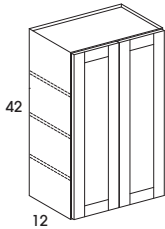

- Two butt doors
- Three adjustable shelves
- Available widths: 24"-36"

W2442DD

8.0

568

W2742

9.0

583

W3042

9.5

626

W3342

10.5

660

W3642

11.5

713

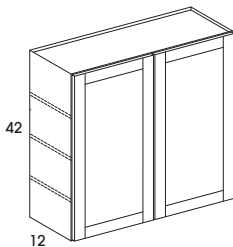

- Two doors, cabinet with center stile
- Three adjustable shelves
- Available width: 42"

W4242

13.5

823

Wall Cabinets – 12" and 24" Deep

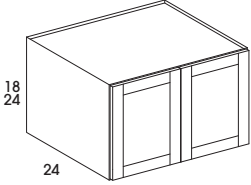
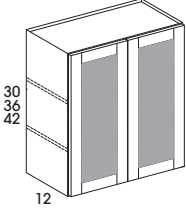
	SKU	cubes	Standard Price
<b>REFRIGERATOR WALL - 24" DEEP</b>			
 <ul style="list-style-type: none"> <li>• Two butt doors</li> <li>• 18" high - shelf not available</li> <li>• 24" high - one adjustable shelf</li> <li>• Available width: 36"</li> </ul>	RW3618	9.5	456
	RW3624	12.5	604
<b>WALL WITH GLASS DOORS</b>			
 <ul style="list-style-type: none"> <li>• <b>Glass cabinets have matching interior and exterior, including top and bottom</b></li> <li>• Two butt doors</li> <li>• 30" and 36" high - two adjustable shelves</li> <li>• 42" high - three adjustable shelves</li> <li>• 90° flat-front shelves are edge banded to match interior</li> <li>• Glass and glass clips are installed</li> <li>• Available width: 30"</li> </ul>	WMD3030	7.0	1296
	WMD3036	8.5	1408
	WMD3042	9.5	1469

Wall Cabinets – 12" Deep

Design Tips:

- All single-door cabinets are hinged left
- Cabinets can be flipped during installation for right hinge applications

SKU

depth

Standard Price

DIAGONAL CORNER WALL – 12" DEEP

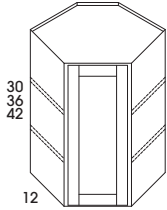

- Single door
- 30" and 36" high – two adjustable shelves
- 42" high – three adjustable shelves

WDC2430

10.0

637

WDC2436

12.0

667

WDC2442

14.0

732

WALL CORNER – 12" DEEP

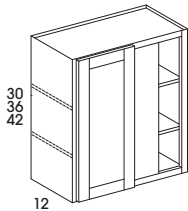

- One door
- Hinged left
- 30" and 36" high – two adjustable shelves
- 42" high – three adjustable shelves
- Blind cabinets can be pulled 3"
- Blind opening is 7" on all sizes
- Does not include filler
- Available width: 30"

WC3030

7.0

422

WC3036

8.0

626

WC3042

9.5

681

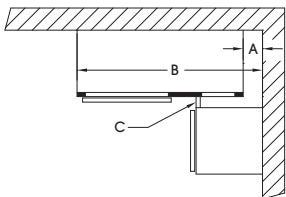

SKU	Cabinet Width	Blind Opening	Center Stile	A		B		Hardware
				Minimum	Maximum	Minimum	Maximum	
WC30_	30"	6"	9"	0"	3 <sup>3</sup> / <sub>4</sub> "	30"	33 <sup>3</sup> / <sub>4</sub> "	N/A

A = Pull distance from wall  
B = Cabinet distance from wall

Note: Blind openings are right side; cabinet will be flipped during installation for left blind applications.

Base Cabinets – 24" Deep

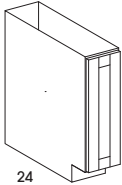
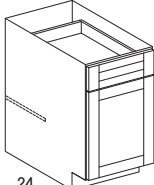
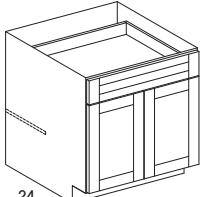
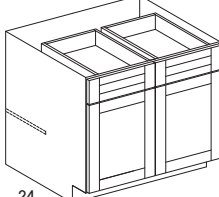
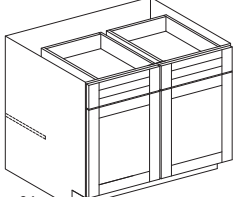
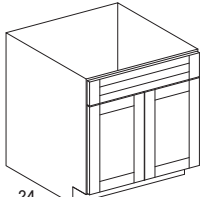
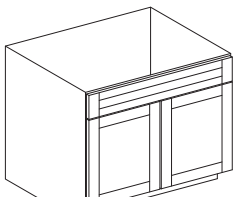
Design Tips:		SKU	depth	Standard Price
<ul style="list-style-type: none"> <li>All single-door cabinets are hinged left</li> <li>Doors will be reversed during installation for right hinge applications</li> </ul>				
BASE - 34 1/2" HIGH – 24" DEEP				
 <p>34 1/2 24</p>	<ul style="list-style-type: none"> <li>One full height door</li> <li>Does not include adjustable shelf</li> <li>Available width: 9"</li> </ul>	B09FH	4.5	482
 <p>34 1/2 24</p>	<ul style="list-style-type: none"> <li>Single door</li> <li>One drawer</li> <li>One adjustable half-depth shelf</li> <li>Available widths: 12"-21"</li> </ul>	B12	6.0	515
		B15	7.5	567
		B18	9.0	609
		B21	10.5	637
 <p>34 1/2 24</p>	<ul style="list-style-type: none"> <li>Two butt doors</li> <li>One drawer</li> <li>One adjustable half-depth shelf</li> <li>Available widths: 24"-30"</li> </ul>	B24DD	12.0	751
		B27	13.5	763
		B30	15.0	809
 <p>34 1/2 24</p>	<ul style="list-style-type: none"> <li>Two butt doors</li> <li>Two drawers</li> <li>One adjustable half-depth shelf</li> <li>Available widths: 33" and 36"</li> </ul>	B33	16.0	851
		B36	18.0	987
 <p>34 1/2 24</p>	<ul style="list-style-type: none"> <li>Two doors, cabinet with center stile</li> <li>Two drawers</li> <li>One adjustable half-depth shelf</li> <li>Available widths: 39" and 42"</li> </ul>	B39	19.5	1085
		B42	21.0	1106
SINK BASE – 34 1/2" HIGH – 24" DEEP				
 <p>34 1/2 24</p>	<ul style="list-style-type: none"> <li>Two butt doors</li> <li>One false panel</li> <li>Available widths: 30"-36"</li> </ul>	SB30	15.0	583
		SB33	16.5	609
		SB36	18.0	626
 <p>34 1/2 24</p>	<ul style="list-style-type: none"> <li>Two doors, cabinet with center stile</li> <li>Available width: 39"</li> </ul>	SB39	19.5	645

Base Cabinets – 24" Deep

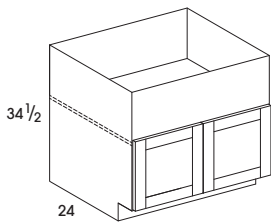
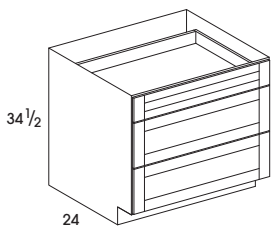
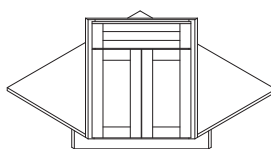
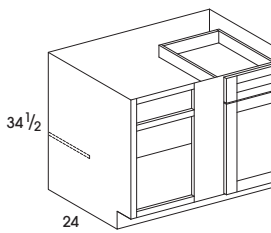
	SKU	Blind Opening	Standard Price
<b>FARM SINK BASE – 34 1/2" HIGH – 24" DEEP</b>			
 <ul style="list-style-type: none"> <li>• Two butt doors</li> <li>• Maximum cut out height: 12"</li> <li>• Trimmable fixed shelf</li> <li>• Available width: 36"</li> </ul>	FSB36	18.0	941
<b>THREE DRAWER BASE – 34 1/2" HIGH – 24" DEEP</b>			
 <ul style="list-style-type: none"> <li>• Three drawers</li> <li>• Available widths: 12"-36"</li> </ul>	DB12D3	6.0	823
	DB15D3	7.5	884
	DB18D3	9.0	946
	DB21D3	10.5	1006
	DB24D3	12.0	1064
	DB30D3	15.0	1242
	DB36D3	18.0	1314
<b>SINK FRONT DIAGONAL WITH FLOOR – 34 1/2" HIGH</b>			
 <ul style="list-style-type: none"> <li>• Single door</li> <li>• One false panel</li> <li>• Front, floor, and toekick only</li> <li>• No side panels</li> <li>• Assembly required - field installation only</li> </ul>	SCB42FF	3.2	472
<b>BASE CORNER – 34 1/2" HIGH – 24" DEEP</b>			
 <ul style="list-style-type: none"> <li>• One door</li> <li>• One drawer</li> <li>• Drawer and door on right, can be reversed during installation</li> <li>• One adjustable half-depth shelf</li> <li>• Center stile is 6"</li> <li>• Does not include filler</li> <li>• Available widths: 42"-48"</li> </ul>	BC42	18.0	748
	BC45	21.0	829
	BC48	24.0	910

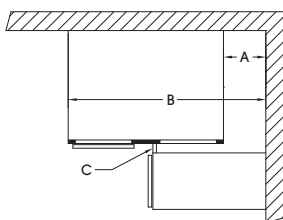

SKU	Cabinet Width	Blind Opening	Center Stile	A		B		Hardware
				Minimum	Maximum	Minimum	Maximum	
BC42	33"	9"	12"	6"	9"	39"	42"	N/A
BC45	39"	12"	12"	6"	6"	42"	45"	
BC48	42"	15"	9"	3"	6"	45"	48"	

A = Pull distance from wall  
 B = Cabinet distance from wall

Note: Blind openings are right side: door and drawer can be reversed during installation for left blind application.

Base Cabinets – 24" Deep

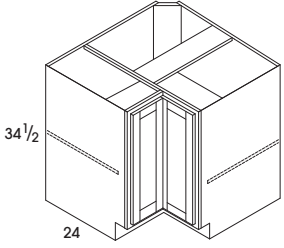
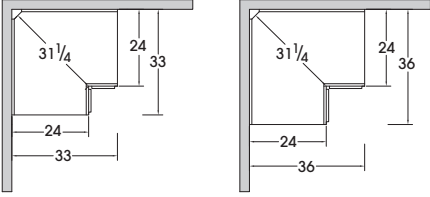
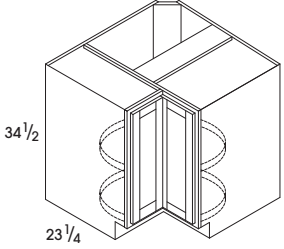
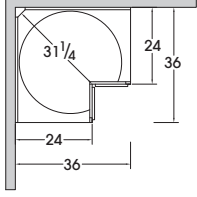
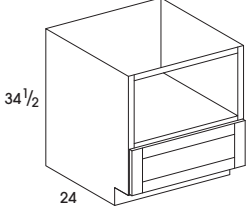
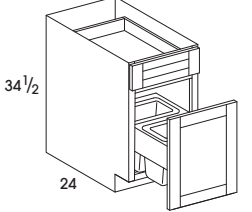
	SKU	cubes	Standard Price
<b>BASE EASY REACH – 34 1/2" HIGH</b>			
 <ul style="list-style-type: none"> <li>• Bifold doors</li> <li>• Two adjustable shelves</li> <li>• Opening for BER33 is 10 1/4"</li> <li>• Opening for BER36 is 11 1/2"</li> <li>• Distance from the corner is 31 1/4"</li> <li>• Available widths: 33" and 36"</li> </ul>	BER33	15.0	775
		BER36	18.0
<b>BASE SUPER SUSAN – 34 1/2" HIGH</b>			
 <ul style="list-style-type: none"> <li>• Bifold doors</li> <li>• Independent rotating plastic shelves, center pole</li> <li>• 32" diameter lazy susan</li> <li>• Opening is 10 1/4"</li> <li>• Distance from the corner is 31 1/4"</li> <li>• Available width: 36"</li> </ul>	SS36	26.0	1394
			
<b>BASE MICROWAVE CABINET – 34 1/2" HIGH – 24" DEEP</b>			
 <ul style="list-style-type: none"> <li>• <b>Matching interior in shelf area</b></li> <li>• Opening: 27" wide x 15 3/4" high</li> <li>• One lower drawer</li> <li>• Available width: 30"</li> </ul>	BMW30	15.0	956
<b>BASE WASTEBASKET CABINET – 34 1/2" HIGH – 24" DEEP</b>			
 <ul style="list-style-type: none"> <li>• Top mounted wastebaskets</li> <li>• Includes two white 35-quart trash cans</li> <li>• Wastebasket - Full-extension, side-mount ball bearing glides with Soft Close</li> <li>• Available width: 18"</li> </ul>	BWB18	9.0	1150

Shelves

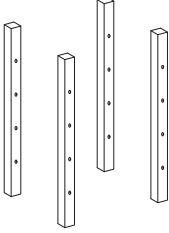
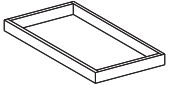
	SKU	cupbes	All Door Styles Used in 24" deep cabinets		
<b>PULL-OUT INSTALL KIT (REQUIRED WITH PULL-OUT SHELVES)</b>					
 <ul style="list-style-type: none"> <li>• Required to install pull-out shelves with Soft Close glides</li> <li>• Cannot be used with 39", 42", or 48" wide cabinets</li> <li>• Multiple pull-out shelves can be used with one installation kit</li> <li>• Kits include four pilasters with predrilled holes and mounting hardware</li> <li>• Tall cabinets require two installation kits, depending on tray locations</li> <li>• Quick and easy to install one or multiple Pull-out shelves</li> <li>• Eliminates measuring and drilling</li> </ul>	ROINSTKIT	1.0	142		
<b>PULL-OUT SHELF FOR BASE AND TALL CABINETS</b>					
 <ul style="list-style-type: none"> <li>• <b>PULL-OUT TRAYS WITH SOFT CLOSE (POSSC) REQUIRE PULL-OUT INSTALL KIT (ROINSTKIT)</b></li> <li>• <b>POSSC - Soft Close, undermount, full extension glides</b></li> <li>• <b>POS - Epoxy side-mounted glides; 3/4 extension</b></li> <li>• Single drawer</li> <li>• Inside height - 1 1/2"</li> <li>• Overall height - 2 1/4"</li> <li>• Solid wood dovetail construction</li> <li>• Includes 5/8" thick dovetailed drawer</li> <li>• 75 lb. capacity per shelf</li> <li>• <b>FIELD INSTALLED</b></li> <li>• Available widths: 12"-36"</li> </ul>	POS12 7 1/2" x 21"	1.0	94	POSSC12 7 1/2" x 21"	197
	POS15 10 1/2" x 21"	1.0	106	POSSC15 10 1/2" x 21"	206
	POS18 13 1/2" x 21"	1.0	121	POSSC18 13 1/2" x 21"	215
	POS21 16 1/2" x 21"	1.0	133	POSSC21 16 1/2" x 21"	221
	POS24 19 1/2" x 21"	1.0	145	POSSC24 19 1/2" x 21"	228
	POS27 22 1/2" x 21"	1.0	151	POSSC27 22 1/2" x 21"	239
	POS30 25 1/2" x 21"	1.0	161	POSSC30 25 1/2" x 21"	245
	POS33 28 1/2" x 21"	1.0	182	POSSC33 28 1/2" x 21"	252
	POS36 31 1/2" x 21"	1.0	189	POSSC36 31 1/2" x 21"	260

Tall Cabinets – 24" Deep

<p><b>Design Tips:</b></p> <ul style="list-style-type: none"> <li>All single-door cabinets are hinged left</li> <li>Doors will be reversed during installation for right hinge applications</li> </ul>	SKU	cubes	Standard Price
--	-----	-------	----------------

UTILITY CABINET – 24" DEEP

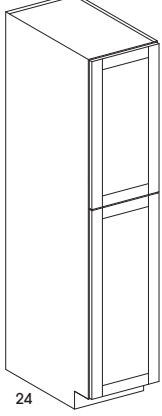
 <ul style="list-style-type: none"> <li>Two doors</li> <li>84" and 90" high – six adjustable shelves</li> <li>96" high - seven adjustable shelves</li> <li><b>Unfinished toekick is attached to all utility cabinets</b></li> <li>Available width: 18"</li> </ul>	U188424	22.0	1021
	U189024	23.5	1119
	U189624	25.0	1189

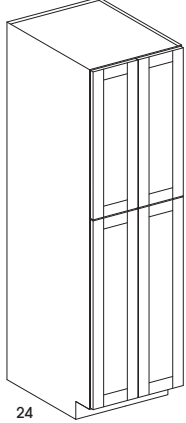
 <ul style="list-style-type: none"> <li>Four butt doors</li> <li>84" and 90" high – six adjustable shelves</li> <li>96" high - seven adjustable shelves</li> <li><b>Unfinished toekick is attached to all utility cabinets</b></li> <li>Available width: 24"</li> </ul>	U248424	29.5	1415
	U249024	31.5	1494
	U249624	33.5	1629

DOUBLE OVEN – 24" DEEP

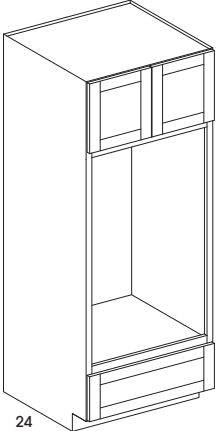
 <ul style="list-style-type: none"> <li>Two butt doors</li> <li>One shelf included in upper cabinet</li> <li>Inside opening is natural</li> <li>One drawer</li> <li>Available width: 33"</li> </ul> <table border="1" data-bbox="73 1808 662 1902"> <thead> <tr> <th colspan="3">Oven Cabinet</th> </tr> <tr> <th>SKU</th> <th>Oven Opening</th> <th>Upper Cabinet Opening</th> </tr> </thead> <tbody> <tr> <td>OCD339624</td> <td>30" wide x 52 1/2" high</td> <td>30" wide x 21" high</td> </tr> </tbody> </table>	Oven Cabinet			SKU	Oven Opening	Upper Cabinet Opening	OCD339624	30" wide x 52 1/2" high	30" wide x 21" high	OCD339624	46.0	2372
Oven Cabinet												
SKU	Oven Opening	Upper Cabinet Opening										
OCD339624	30" wide x 52 1/2" high	30" wide x 21" high										

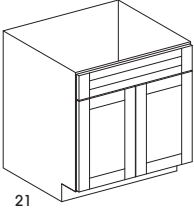
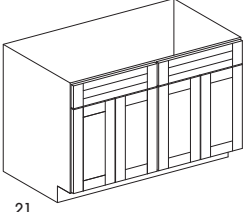
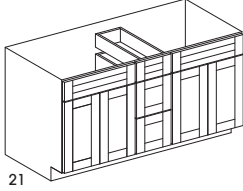
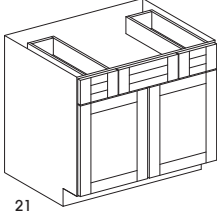
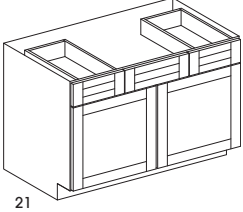

Vanity Cabinets – 21" Deep

	SKU	cubes	Standard Price
<b>VANITY SINK BASE – 34 1/2" HIGH – 21" DEEP</b>			
 <ul style="list-style-type: none"> <li>• Two butt doors</li> <li>• One false panel</li> <li>• Available widths: 24"-36"</li> </ul>	VSB24DD	11.0	483
	VSB27	12.0	498
	VSB30	13.5	534
	VSB33	15.0	552
	VSB36	16.5	575
 <ul style="list-style-type: none"> <li>• Four doors with center mullion</li> <li>• Two false panels</li> <li>• Available width: 48"</li> </ul>	VSB48	21.5	688
<b>VANITY SINK DRAWER BASE – 34 1/2" HIGH – 21" DEEP</b>			
 <ul style="list-style-type: none"> <li>• Two sets of butt doors</li> <li>• Two false fronts</li> <li>• Three drawers in center</li> <li>• Center drawers area is 12" wide</li> <li>• Available width: 60"</li> </ul>	VSB60DB3	26.8	1956
<b>VANITY SINK DRAWER BASE – 34 1/2" HIGH – 21" DEEP</b>			
 <ul style="list-style-type: none"> <li>• Two butt doors</li> <li>• Two drawers</li> <li>• One false panel</li> <li>• Available width: 36"</li> </ul>	VSDB36	16.0	853
 <ul style="list-style-type: none"> <li>• Two doors, cabinet with center stile</li> <li>• Two drawers</li> <li>• One false panel</li> <li>• Available widths: 42" and 48"</li> </ul>	VSDB42	18.0	1003
	VSDB48	21.5	1060

Vanity Cabinets – 21" Deep

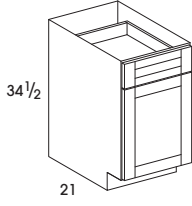
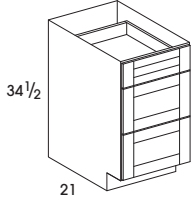
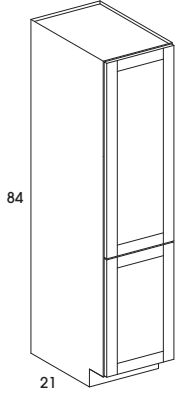
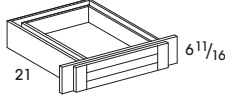
Design Tips:		SKU	cubes	Standard Price
<ul style="list-style-type: none"> <li>All single-door cabinets are hinged left</li> <li>Doors will be reversed during installation for right hinge applications</li> </ul>				
<b>VANITY BASE CABINET – 34 1/2" HIGH – 21" DEEP</b>				
 <ul style="list-style-type: none"> <li>Single door</li> <li>One drawer</li> <li>Available widths: 12"-18"</li> </ul>	VB12	5.5	493	
	VB15	7.0	498	
	VB18	8.0	541	
<b>VANITY DRAWER BASE CABINET – 34 1/2" HIGH – 21" DEEP</b>				
 <ul style="list-style-type: none"> <li>Three drawers</li> <li>Available widths: 12"-18"</li> </ul>	VDB12D3	5.8	681	
	VDB15D3	7.1	739	
	VDB18D3	8.4	775	
<b>LINEN CABINET – 21" DEEP</b>				
 <ul style="list-style-type: none"> <li>Two doors</li> <li>Six adjustable shelves included</li> <li>Unfinished toekick is attached</li> <li>Available width: 15"</li> </ul>	LC158421	16.5	1025	
<b>UNDERMOUNT DRAWER – 21" DEEP</b>				
 <ul style="list-style-type: none"> <li>Trimmable to 24" wide</li> <li>Drawer front is 6<sup>3</sup>/<sub>16</sub>" high</li> <li>Available width: 30"</li> </ul>	VDT30	8.7	375	

Accessories

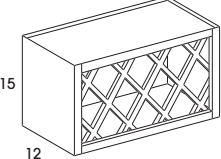
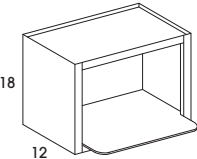
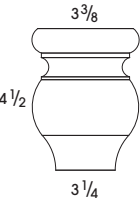
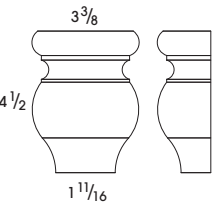
	SKU	cubes	Standard Price
<b>WINE RACK - 18" HIGH - 12" DEEP</b>			
 <ul style="list-style-type: none"> <li>• Matching interior</li> <li>• Finished exterior on all sides</li> <li>• Rack holds 11 bottles</li> <li>• Available width: 30"</li> </ul>	WR30	3.5	1004
<b>MICROWAVE WALL CABINET - 12" DEEP</b>			
 <ul style="list-style-type: none"> <li>• Opening dimensions: 27" wide x 14 1/2" tall</li> <li>• Includes 17 1/16" deep, 5/16" thick plywood shelf. Ships loose and is accompanied by a spacer strip to be placed in the bottom of the cabinet to level the shelf</li> <li>• Matching interior</li> <li>• Finished exterior on all sides</li> <li>• Available width: 30"</li> </ul>	MWC3018	4.5	613
<b>BUN FOOT</b>			
 <ul style="list-style-type: none"> <li>• 4 1/2" high x 3 3/8" wide</li> <li>• 3 1/4" deep</li> </ul>	BFOOT	0.1	130
<b>HALF BUN FOOT</b>			
 <ul style="list-style-type: none"> <li>• 4 1/2" high x 3 3/8" wide</li> <li>• 1 11/16" deep</li> </ul>	BFOOTHALF	0.1	120

Accessories

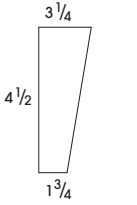
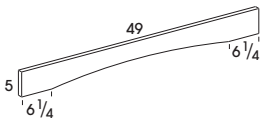
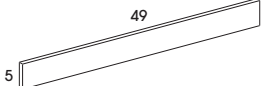
	SKU	cubes	Standard Price
<b>TAPERED FOOT</b>			
 <ul style="list-style-type: none"> <li>• 3 1/4" wide at the top</li> <li>• 1 3/4" wide at the bottom</li> <li>• 4 1/2" high</li> </ul>	TFOOT	0.1	130
<b>HALF TAPERED FOOT</b>			
 <ul style="list-style-type: none"> <li>• 3 1/4" wide x 1 5/8" deep at the top</li> <li>• 1 3/4" wide x 7/8" deep at the bottom</li> <li>• 4 1/2" high</li> </ul>	TFOOTHALF	0.1	120
<b>ROMAN ARCH VALANCE</b>			
 <ul style="list-style-type: none"> <li>• All valances are 3/4" thick solid maple</li> <li>• Available width: 49"</li> </ul>	V549RA	0.2	145
<b>STRAIGHT VALANCE</b>			
 <ul style="list-style-type: none"> <li>• All valances are 3/4" thick solid maple</li> <li>• Finished two sides; Front face and profiled edge</li> <li>• Available width: 49"</li> </ul>	V549ST	0.2	94

Fillers & Panels

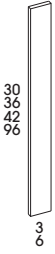
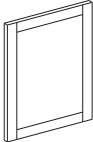
		SKU	cubes	Standard Price														
<b>FILLER - STANDARD</b>																		
 <ul style="list-style-type: none"> <li>• Fillers are 3/4" thick solid maple</li> <li>• Fillers are finished on the face, left, and right sides; however, the sides receive a lesser finish</li> <li>• If you require an end to be exposed, we suggest using a valance</li> <li>• F330 and F360 may be used for either bases or 30" walls</li> <li>• Available widths: 3" and 6"</li> </ul>	F330	0.1	61															
	F630	0.2	125															
	WF336	0.1	69															
	WF636	0.2	149															
	WF342	0.1	90															
	WF642	0.2	164															
	F396	0.2	164															
	F696	0.4	330															
<b>DECORATIVE END PANELS</b>																		
 <ul style="list-style-type: none"> <li>• All decorative end panels are actual doors that are finished on both sides</li> </ul> <table border="1" data-bbox="159 1528 750 1675"> <thead> <tr> <th>SKU</th> <th>Width</th> <th>Height</th> </tr> </thead> <tbody> <tr> <td>DWEP30</td> <td>11 1/8"</td> <td>29 1/2"</td> </tr> <tr> <td>DWEP36</td> <td>11 1/8"</td> <td>35 1/2"</td> </tr> <tr> <td>DWEP42</td> <td>11 1/8"</td> <td>41 1/2"</td> </tr> <tr> <td>DEPB</td> <td>23 1/8"</td> <td>29 5/16"</td> </tr> </tbody> </table>	SKU	Width	Height	DWEP30	11 1/8"	29 1/2"	DWEP36	11 1/8"	35 1/2"	DWEP42	11 1/8"	41 1/2"	DEPB	23 1/8"	29 5/16"	DWEP30	4.5	221
	SKU	Width	Height															
	DWEP30	11 1/8"	29 1/2"															
	DWEP36	11 1/8"	35 1/2"															
	DWEP42	11 1/8"	41 1/2"															
DEPB	23 1/8"	29 5/16"																
DWEP36	6.7	251																
DWEP42	8.4	272																
DEPB	7.5	283																

Fillers & Panels

	SKU	cubes	Standard Price
<b>PANELS</b>			
<b>P4836:</b> Finished End Panel — 48" x 36" x 3/16" (grain runs with 36") — Painted plywood	P4836	8.0	249
<b>P9648:</b> Finished End Panel — 96" x 48" x 3/16" (grain runs with 48") — Painted plywood	P9648	21.4	415
<b>BP4896:</b> Finished Beaded Panel — 48" x 96" x 1/4" (bead runs with 96") — Painted plywood — spacing between beads is approximately 1 5/16"	BP4896	36.6	722
<b>WSKIN:</b> Finished Panel — 11 1/4" x 42" x 1/4" — Painted plywood	WSKIN	9.0	107
<b>WSKIN15:</b> Finished Panel — 14 1/4" x 42" x 1/4" — Painted plywood	WSKIN15	1.0	125
<b>BSKIN:</b> Finished Panel — 23 1/4" x 34 1/2" x 1/4" — Painted plywood on one side	BSKIN	5.7	149
<b>*REFP24:</b> Finished Refrigerator Panel — 24" x 96" with 1 1/2" stile — 1/2" Painted Plywood Assembly required - field installation only	REFP24	25.6	373
<b>3/4REFP24:</b> Finished Refrigerator Panel — 24" x 96" with 3/4" stile — Panel finished on two sides & one long edge. 1/2" Painted Plywood Assembly required - field installation only	3/4REFP24	24.7	373
<b>*REFP30:</b> Finished Refrigerator Panel — 30" x 96" with 1 1/2" stile — 1/2" Painted Plywood Assembly required - field installation only	REFP30	32.0	421
<b>3/4REFP30:</b> Finished Refrigerator Panel — 30" x 96" with 3/4" stile — Panel finished on two sides & one long edge. 1/2" Painted Plywood Assembly required - field installation only	3/4REFP30	31.5	880
<b>*DWP1.5:</b> Dishwasher End Panel with 1 1/2" filler — 24" x 34 1/2" with 1 1/2" stile — 1/2" Painted Plywood on all sides. Assembly required - field installation only	DWP1.5	4.4	203
<b>*DWP3:</b> Dishwasher End Panel with 3" filler — 24" x 34 1/2" with 3" stile — 1/2" Painted Plywood on all sides. Assembly required - field installation only	DWP3	5.7	209
<b>*DWP6:</b> Dishwasher End Panel with 6" filler — 24" x 34 1/2" tall with 6" stile — 1/2" Painted plywood. Assembly required - field installation only	DWP6	12.2	358

Mouldings

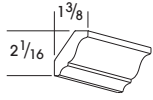
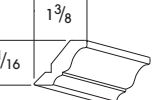
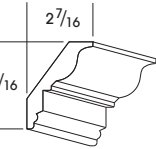
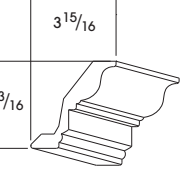
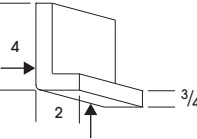
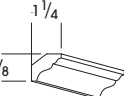
	SKU	cubes	Standard Price
<b>SMALL CROWN</b>			
 <ul style="list-style-type: none"> <li>• Crown Moulding</li> <li>• 8 feet long</li> <li>• Available in all colors</li> </ul>	SMCROWN214	0.3	137
<b>SMALL CROWN - TOP MOUNT</b>			
 <ul style="list-style-type: none"> <li>• Top Mount Crown Moulding</li> <li>• Seated on top of cabinet with 3/8" top nailing flange</li> <li>• 8 feet long</li> <li>• Available in all colors</li> </ul>	SSMCROWN214	0.4	169
<b>LARGE CROWN</b>			
 <ul style="list-style-type: none"> <li>• Crown Moulding</li> <li>• 8 feet long</li> <li>• Available in all colors</li> </ul>	LGCROWN4	0.5	192
<b>LARGE CROWN - TOP MOUNT</b>			
 <ul style="list-style-type: none"> <li>• Top Mount Crown Moulding</li> <li>• 8 feet long</li> <li>• Available in all colors</li> </ul>	SLGCROWN4	0.4	275
<b>STARTER CROWN</b>			
 <ul style="list-style-type: none"> <li>• 4" Starter Crown Moulding; not finished on back</li> <li>• Arrows identify finished sides</li> <li>• 8 feet long</li> <li>• Available in all colors</li> </ul>	STCROWN	1.0	485
<b>COVE CROWN</b>			
 <ul style="list-style-type: none"> <li>• 1 3/4" Cove Crown Moulding</li> <li>• 8 feet long</li> <li>• Available in all colors</li> </ul>	CCROWN134	0.2	106

Mouldings

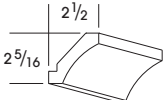
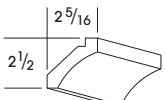
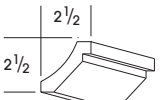
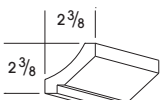
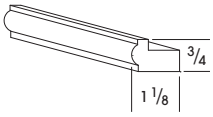
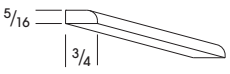
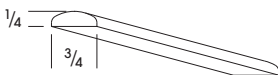
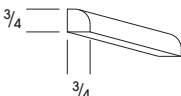
	SKU	cubes	Standard Price
<b>REVERSIBLE CROWN</b>			
 <p><b>Cove-Fo</b></p> <ul style="list-style-type: none"> <li>• 4-way adjustable Cove and Shaker Moulding combo</li> <li>• 8 feet long</li> <li>• Available in all colors</li> </ul>  <p><b>Cove-So</b></p>  <p><b>Shaker-Fo</b></p>  <p><b>Shaker-Fo</b></p>	REVCROWN	0.4	222
<b>LIGHT RAIL</b>			
 <ul style="list-style-type: none"> <li>• Light Rail Moulding</li> <li>• 8 feet long</li> <li>• Available in all colors</li> </ul>	MLR	0.2	98
<b>SCRIBE</b>			
 <ul style="list-style-type: none"> <li>• Scribe Moulding</li> <li>• 8 feet long</li> <li>• Available in all colors</li> </ul>	MSW	0.1	67
<b>BATTEN</b>			
 <ul style="list-style-type: none"> <li>• Batten Moulding</li> <li>• 8 feet long</li> <li>• Available in all colors</li> </ul>	MBAT	0.1	69
<b>QUARTER ROUND</b>			
 <ul style="list-style-type: none"> <li>• Quarter Round Moulding</li> <li>• 8 feet long</li> <li>• Available in all colors</li> </ul>	MQR	0.2	81

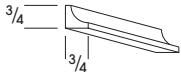
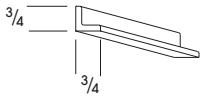
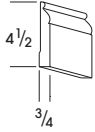
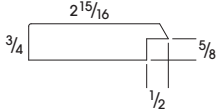
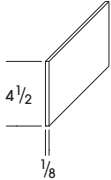
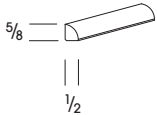

Mouldings

	SKU	cases	Standard Price
<b>INSIDE CORNER</b>			
 <ul style="list-style-type: none"> <li>• Inside Corner Moulding</li> <li>• 8 feet long</li> <li>• Available in all colors</li> </ul>	MICW	0.1	98
<b>OUTSIDE CORNER</b>			
 <ul style="list-style-type: none"> <li>• Outside Corner Moulding</li> <li>• 8 feet long</li> <li>• Available in all colors</li> </ul>	MOCW	0.2	98
<b>FURNITURE BASE</b>			
 <ul style="list-style-type: none"> <li>• 4 1/2" Furniture Base Moulding</li> <li>• 8 feet long</li> <li>• Available in all colors</li> </ul>	FB	0.5	207
<b>MIRROR MOLDING</b>			
 <ul style="list-style-type: none"> <li>• 8 feet long</li> <li>• Available in all colors</li> </ul>	MMIR	0.2	258
<b>TOEKICK - 4 1/2"</b>			
 <ul style="list-style-type: none"> <li>• 4 1/2" Toekick (Plywood w/vinyl veneer)</li> <li>• 8 feet long</li> <li>• Available in all colors</li> </ul>	TOEKICK	1.7	66
<b>SHOE</b>			
 <ul style="list-style-type: none"> <li>• Shoe Moulding</li> <li>• 8 feet long</li> <li>• Available in all colors</li> </ul>	MSHOE	0.1	81

## Hardware

IN STOCK

		Description	List
<b>BIFDOORHINGE</b>	4014113	Attaches door to cabinet frame on BER	54
<b>BIFDOORPLATE</b>	4014114	Attaches door to cabinet frame on BER / Attaches door to door on BER - Cabinet utilizes four of these	12.53
<b>BIFPIANOHINGE</b>	4014115	Attaches door to door on BER	73
<b>BUMPERPAD</b>	1236889	Bumper pads 200/sheet (clear)	12.53
<b>CGINIVSOCKET</b>	4014123	Cabinet Glide - Universal Socket - 2 Pcs	5.33
<b>FALSEFRONTBRK</b>	4014116	Bracket that secures false front to frame	.61
<b>SOFTHINGE6</b>	4014118	Full Overlay Soft Close Hinge, 6 Way Adjustable	22
<b>SCREWS</b>	4014117	Screws	0.15
<b>SHPIN</b>	4014122	Shelf Pin 5 mm (sold individually)	0.61
<b>UMDRWLOCKSET</b>	4014120	Undermount drawer clip—L and R - comes in pair	10.82
<b>UMBCGLIDE</b>	4014119	Full-extension glide for base cabinets - Set	157
<b>UMVCGLIDE</b>	4014121	Full-extension glide for vanity cabinets - Set	148

List price is each unless otherwise noted in the description.

	IN STOCK					
FINISH	TOUCH-UP KITS	LIST EACH	PAINT	LIST PINT	SPRAY	LIST 12 OZ. CAN (NO PRIMER)
DIAMOND	3952827	73	3952828	97	3952829	84
SHALE	3953161	73	3953162	97	3953163	84
TOP COAT	—	—	1414350	121 (QUART)	1915465	123 12 OZ CAN

**Special order Touch-up Markers and Fill sticks will be shipped direct.**

Touch-up kits include 1 putty fill stick, 1 touch-up marker and 1 small bottle of top coat

Wolf pints of paint are for touch up purposes only. When doing a color match for a larger project we recommend taking a door to a professional paint store to do a color match.

Wall Cabinets – 12" and 24" Deep

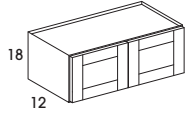
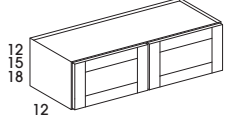
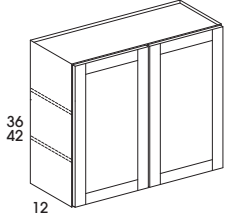
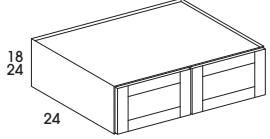
Design Tips: • Special Order items are not in stock and require a longer lead time to deliver		SKU	cubes	Standard Price
<b>WALL – 18" HIGH – 12" DEEP</b>				
 <ul style="list-style-type: none"> <li>• Two butt doors</li> <li>• Shelves not available</li> <li>• Available width: 21"</li> </ul>	W2118	3.2	308	
<b>WALL – 39" WIDE – 12" DEEP</b>				
 <ul style="list-style-type: none"> <li>• Two doors, cabinet with center stile</li> <li>• Shelves not available</li> <li>• Available width: 39"</li> </ul>	W3912	3.5	430	
	W3915	4.5	493	
	W3918	5.5	557	
<b>WALL – 39" WIDE – 12" DEEP</b>				
 <ul style="list-style-type: none"> <li>• Two doors, cabinet with center stile</li> <li>• 36" high - two adjustable shelves</li> <li>• 42" high - three adjustable shelves</li> <li>• Available width: 39"</li> </ul>	W3936	11.0	703	
	W3942	12.5	768	
<b>REFRIGERATOR WALL - 39" WIDE - 24" DEEP</b>				
 <ul style="list-style-type: none"> <li>• Two doors, cabinet with center stile</li> <li>• Shelves not available</li> <li>• Available width: 39"</li> </ul>	RW3918	10.5	698	
	RW3924	14.0	708	

Wall Cabinets – 12" Deep

Design Tips:

- All single-door cabinets are hinged left
- Cabinets can be flipped during installation for right hinge applications
- **Special Order items are not in stock and require a longer lead time to deliver**

SKU

cubes

Standard Price

WALL WITH GLASS DOORS – 12" DEEP

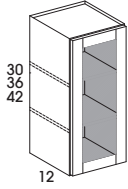

- **Glass cabinets have matching interior and exterior, including top and bottom**
- Single door
- 30" and 36" high - two adjustable shelves
- 42" high - three adjustable shelves
- 90° flat-front shelves are edge banded to match interior
- Glass and glass clips are included
- Available width: 15"

WMD1530

3.5

645

WMD1536

4.5

728

WMD1542

5.0

748

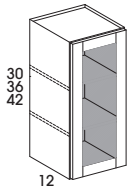

- **Glass cabinets have matching interior and exterior, including top and bottom**
- Single door
- 30" and 36" high - two adjustable shelves
- 42" high - three adjustable shelves
- 90° flat-front shelves are edge banded to match interior
- Glass and glass clips are included
- Available width: 18"

WMD1830

4.5

695

WMD1836

5.0

781

WMD1842

6.0

845

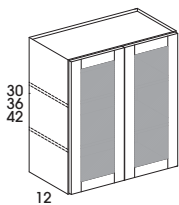

- **Glass cabinets have matching interior and exterior, including top and bottom**
- Two butt doors
- 30" and 36" high - two adjustable shelves
- 42" high - three adjustable shelves
- 90° flat-front shelves are edge banded to match interior
- Glass and glass clips are included
- Available width: 36"

WMD3630

8.5

1383

WMD3636

10.0

1542

WMD3642

11.5

1675

Wall Cabinets – 12" and 15" Deep

<p><b>Design Tips:</b></p> <ul style="list-style-type: none"> <li>All single-door cabinets are hinged left</li> <li>Cabinets can be flipped during installation for right hinge applications</li> <li><b>Special Order items are not in stock and require a longer lead time to deliver</b></li> </ul>	SKU	cubes	Standard Price
--	-----	-------	----------------

**DIAGONAL CORNER WALL WITH GLASS DOOR – 12" DEEP**

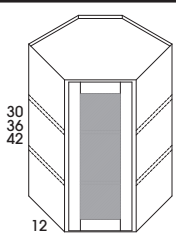
 <ul style="list-style-type: none"> <li><b>Glass cabinets have matching interior and exterior, including top and bottom</b></li> <li>Single door</li> <li>30" and 36" high - two adjustable shelves</li> <li>42" high - three adjustable shelves</li> <li>90° flat-front shelves are edge banded to match interior</li> <li>Glass and glass clips are installed</li> <li>Available width: 24"</li> </ul>	WMDC2430	10.0	1080
	WMDC2436	12.0	1278
	WMDC2442	14.0	1351

**DIAGONAL CORNER WALL WITH GLASS DOOR – 15" DEEP**

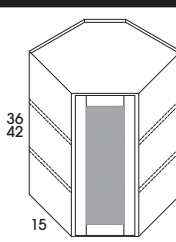
 <ul style="list-style-type: none"> <li><b>Glass cabinets have matching interior and exterior, including top and bottom</b></li> <li>Single door</li> <li>36" high - two adjustable shelves</li> <li>42" high - three adjustable shelves</li> <li>90° flat-front shelves are edge banded to match interior</li> <li>Glass and glass clips are installed</li> <li>Available width: 27"</li> </ul>	WMDC2736	15.5	907
	WMDC2742	18.0	920

**WALL END CABINET – 12" DEEP**

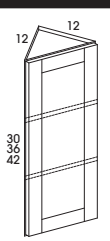
 <ul style="list-style-type: none"> <li>Single door</li> <li>30" and 36" high - two adjustable shelves</li> <li>42" high - three adjustable shelves</li> <li>Available width: 12"</li> </ul>	WEC1230	3.0	309
	WEC1236	3.0	340
	WEC1242	4.0	351

Wall Cabinets – 12" and 15" Deep

Design Tips:

- Special Order items are not in stock and require a longer lead time to deliver

SKU

cubes

Standard Price

DIAGONAL CORNER WALL – 15" DEEP

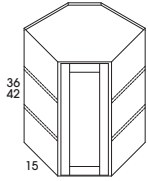

- Single door
- 36" high - two adjustable shelves
- 42" high - three adjustable shelves
- Available width: 27"

WDC2736

15.5

908

WDC2742

18.0

920

MICROWAVE WALL - 36" HIGH - 12" DEEP

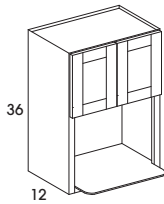

- Two butt doors
- Matching interior
- Designed for free-standing microwaves
- Cannot be installed next to Diagonal Wall Cabinets
- Includes 17<sup>9</sup>/<sub>16</sub>" deep, 5<sup>1</sup>/<sub>16</sub>" thick plywood shelf. Ships loose and is accompanied by a spacer strip to be placed in the bottom of the cabinet to level the shelf
- Opening size is 16<sup>1</sup>/<sub>2</sub>" high x 27" wide
- Available width: 30"

MWC3036

8.0

867

Base Cabinets – 24" Deep

<p><b>Design Tips:</b></p> <ul style="list-style-type: none"> <li>All single-door cabinets are hinged left</li> <li>Doors will be reversed during installation for right hinge applications</li> <li>Special Order items are not in stock and require a longer lead time to deliver</li> </ul>	SKU	cubes	Standard Price
--	-----	-------	----------------

**BASE WITH FULL HEIGHT DOORS – 34 1/2" HIGH – 24" DEEP**

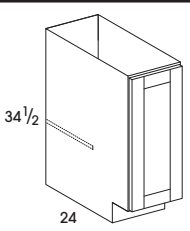
 <ul style="list-style-type: none"> <li>One full height door</li> <li>One adjustable half-depth shelf</li> <li>Available widths: 12"-18"</li> </ul>	B12FH	6.0	466
	B15FH	7.5	519
	B18FH	9.0	562

**BASE FARM SINK – 34 1/2" HIGH – 24" DEEP**

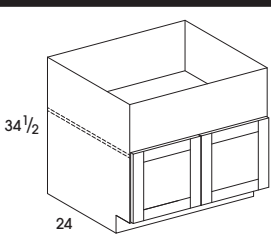
 <ul style="list-style-type: none"> <li>Two butt doors</li> <li>Maximum cut out height: 12"</li> <li>Trimmable fixed shelf</li> <li>Available width: 39"</li> </ul>	FSB39	19.5	946
--	-------	------	-----

**TWO DRAWER BASE – 34 1/2" HIGH – 24" DEEP**

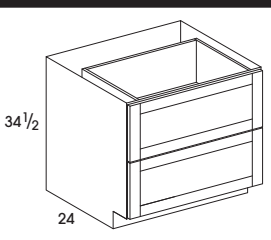
 <ul style="list-style-type: none"> <li>Two drawers</li> <li>Available widths: 30"-36"</li> </ul>	DB30D2	15.0	1242
	DB36D2	18.0	1315



Tall Cabinets – 24" Deep

Design Tips:

- Special Order items are not in stock and require a longer lead time to deliver

SKU

cubes

Standard Price

DOUBLE OVEN – 24" DEEP

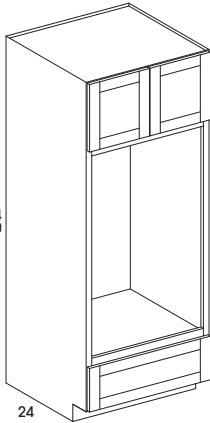

- Two butt doors
- No shelves included in upper cabinet
- Inside opening is natural/white
- One drawer
- Available width: 33"

OCD338424

40.5

2153

OCD339024

43.0

2265

Oven Cabinet		
SKU	Oven Opening	Upper Cabinet Opening
OCD338424	30" wide x 52 1/2" high	30" wide x 9" high
OCD339024	30" wide x 52 1/2" high	30" wide x 15" high

DOUBLE OVEN PANEL OVERLAY

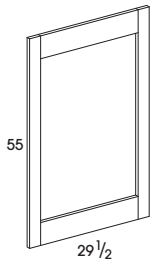

- Trimmable overlay panel
- Assembly required – field installation only
- Four separate pieces:  
Two narrow horizontal pieces - 6" x 26 1/2"  
Two long pieces - 3" x 55"
- Screws provided for field assembly
- Can be used as single pieces or as a completed set
- Minimum opening with overlay = 26 1/2" wide x 43 1/16" high

POCD33

18.2

175

UTILITY CABINET – 24" DEEP

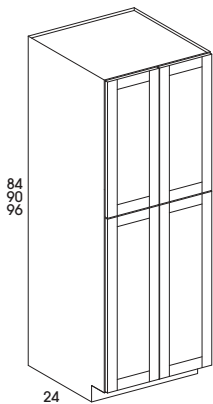

- Four butt doors
- 84" and 90" high – six adjustable shelves
- 96" high – seven adjustable shelves
- Unfinished toekick is attached to all utility cabinets
- Available width: 30"

U308424

36.5

1849

U309024

39.5

1872

U309624

43.6

2000

Vanity Cabinets – 21" Deep

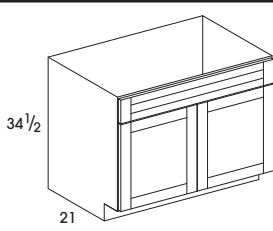
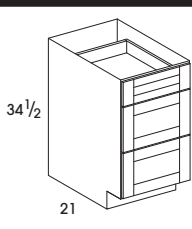
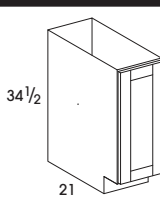
<p><b>Design Tips:</b></p> <ul style="list-style-type: none"> <li>All single-door cabinets are hinged left</li> <li>Doors will be reversed during installation for right hinge applications</li> <li><b>Special Order items are not in stock and require a longer lead time to deliver</b></li> </ul>	SKU	cubes	Standard Price
<b>VANITY SINK BASE – 34 1/2" HIGH – 21" DEEP</b>			
 <ul style="list-style-type: none"> <li>Two doors, cabinet with center stile</li> <li>One false panel</li> <li>Available width: 42"</li> </ul>	VSB42	18.9	631
<b>VANITY DRAWER BASE CABINET – 34 1/2" HIGH – 21" DEEP</b>			
 <ul style="list-style-type: none"> <li>Three Drawers</li> <li>Available width: 21"</li> </ul>	VDB21D3	9.7	815
<b>VANITY BASE CABINET WITH FULL HEIGHT DOORS – 34 1/2" HIGH – 21" DEEP</b>			
 <ul style="list-style-type: none"> <li>One full height door</li> <li>Available width: 12"</li> </ul>	VB12FH	6.0	456

Vanity Cabinets – 21" Deep

Design Tips:

- All single-door cabinets are hinged left
- Doors will be reversed during installation for right hinge applications
- **Special Order items are not in stock and require a longer lead time to deliver**

SKU

cupes

Standard Price

VANITY SINK SIX DRAWER BASE – 34 1/2" HIGH – 21" DEEP

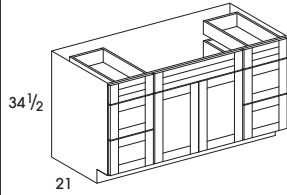

- Butt doors
- One false panel
- Six drawers
- Outside drawer area is 12" wide
- Available width: 60"

VSB60DB6

26.8

2387

LINEN CABINET – 21" DEEP



- Two doors
- Six adjustable shelves included
- Unfinished toekick is attached
- Available width: 18"

LC188421

20.6

1365

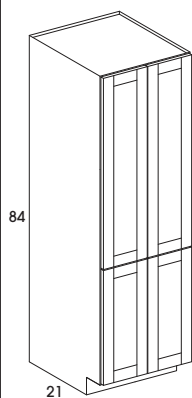

- Four doors
- Six adjustable shelves included
- Unfinished toekick is attached
- Available width: 24"

LC248421

27.1

1765

Range Hoods

<p><b>Design Tips:</b></p> <ul style="list-style-type: none"> <li>Special Order items are not in stock and require a longer lead time to deliver</li> </ul>	SKU	cubes	Standard Price
---	-----	-------	----------------

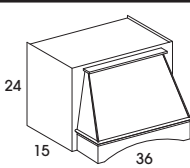

**RANGE HOOD WITH ARCHED VALANCE**

 <ul style="list-style-type: none"> <li>Decorative Hood Only – No blower unit included</li> <li>Decorative trim can be removed from cabinet frame for separate application.</li> <li>Cabinet box dimension: 36" wide x 24" tall x 15" deep</li> <li>Projection is 7 1/2"</li> <li>Overall Dimensions: 36" wide x 24" tall x 22 1/2" deep</li> </ul>	HOODAR36	7.0	750
---	----------	-----	-----

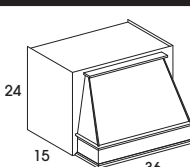
**RANGE HOOD WITH STRAIGHT VALANCE**

 <ul style="list-style-type: none"> <li>Decorative Hood Only – No blower unit included</li> <li>Decorative trim can be removed from cabinet frame for separate application.</li> <li>Cabinet box dimension: 36" wide x 24" tall x 15" deep</li> <li>Projection is 7 1/2"</li> <li>Overall Dimensions: 36" wide x 24" tall x 22 1/2" deep</li> </ul>	HOODST36	7.0	780
---	----------	-----	-----

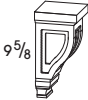
Accessories

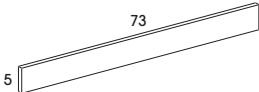
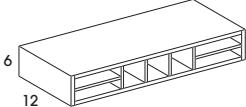
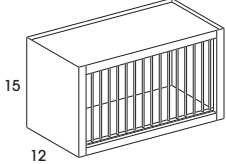
Design Tips: • Special Order items are not in stock and require a longer lead time to deliver		SKU	cubes	Standard Price
<b>CORBEL - BASIC</b>				
 <p>9 5/8</p>	<ul style="list-style-type: none"> <li>• 9 5/8" high x 4 11/16" wide x 4 11/16" deep</li> </ul>	CORBELB9	1.3	225
<b>CORBEL - LARGE CLASSIC SCROLL</b>				
 <p>12</p>	<ul style="list-style-type: none"> <li>• 12" high x 3 1/2" wide x 7 3/16" deep</li> </ul>	CORBELS12	3.0	340
<b>CORBEL - CLASSIC SCROLL</b>				
 <p>6 7/8</p>	<ul style="list-style-type: none"> <li>• 6 7/8" high x 3 3/4" wide x 3 3/4" deep</li> </ul>	CORBELS7	1.5	260
<b>STRAIGHT VALANCE</b>				
 <p>73</p> <p>5</p>	<ul style="list-style-type: none"> <li>• All valances are 3/4" thick solid maple</li> <li>• Finished two sides; Front face and profiled edge</li> <li>• Available width: 73"</li> </ul>	V573ST	0.3	137
<b>ORGANIZER - 6" HIGH - 12" DEEP</b>				
 <p>6</p> <p>12</p>	<ul style="list-style-type: none"> <li>• Matching interior</li> <li>• Finished on all sides</li> <li>• Mount unit between cabinets</li> <li>• Available width: 36"</li> </ul>	ORG36	2.0	895
<b>PLATE RACK - 15" HIGH - 12" DEEP</b>				
 <p>15</p> <p>12</p>	<ul style="list-style-type: none"> <li>• Matching interior</li> <li>• Finished on all sides</li> <li>• Available width: 30"</li> </ul>	PR30	4.5	983

Accessories

<p><b>Design Tips:</b></p> <ul style="list-style-type: none"> <li>Special Order items are not in stock and require a longer lead time to deliver</li> </ul>	SKU	cubes	Standard Price
---	-----	-------	----------------

**DECORATIVE LEG**

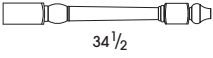
 <p>3 1/2" high x 3 1/2" wide x 3 1/2" deep</p>	LEG	2.8	430
---	-----	-----	-----

**SPLIT DECORATIVE LEG**

 <p>3 1/2" high x 3 1/2" wide x 1 5/8" deep</p>	LEGHALF	2.5	400
---	---------	-----	-----

**DECORATIVE FULL HEIGHT DOOR FRONTS**

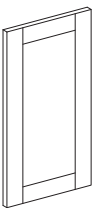

Doors without hinge holes

SKU	Width	Height
B09FHNBDOR	8 17/32"	29 9/32"
B12FHNBDOR	11 17/32"	29 9/32"
B15FHNBDOR	14 17/32"	29 9/32"
B18FHNBDOR	17 17/32"	29 9/32"

B09FHNBDOR	0.1	97
B12FHNBDOR	0.1	167
B15FHNBDOR	0.1	224
B18FHNBDOR	0.1	254

**FINISHED PANELS**

<ul style="list-style-type: none"> <li>Finished Panel - 23 3/4" x 96" x 1/4"</li> <li>Painted plywood</li> </ul>	TSKIN96	22.5	275
--	---------	------	-----

<ul style="list-style-type: none"> <li>Finished End Panel - 36" x 96" x 3/16"</li> <li>Grain runs with 96"</li> <li>Painted plywood</li> </ul>	P3696	16.1	210
--	-------	------	-----

**WOLF CLASSIC | 5-YEAR LIMITED WARRANTY**

Wolf Classic cabinets have been manufactured under the highest standards of quality and workmanship.

**FIVE-YEAR LIMITED WARRANTY ON CABINETS, DRAWER GUIDE AND HINGES**

Wolf Home Products warrants to original consumer purchasers for five years from date of original purchase that cabinets, drawers, drawer guides and hinges used in the manufacture of Wolf Classic cabinets shall be free from defects in material and workmanship under normal use.

**GENERAL WARRANTY GUIDELINES**

Should Wolf Classic cabinets fail during the applicable warranty period due to defects in the material or workmanship under normal use, Wolf Home Products, at its discretion, will repair or provide the parts necessary to replace the defective products.

This warranty is applicable only to products used in residential applications in the United States and is not transferable. This warranty does not cover products that are misused, abused, mishandled, improperly installed, improperly stored, changed, modified or subject to extreme temperatures or extreme moisture levels, or normal wear and tear. This warranty is not valid for products used for any purpose other than the purpose for which they were originally intended. This warranty does not cover the cost of installation, removal, subsequent damage or transportation of the defective product, regardless of whether the work was performed by a contractor, service company or the consumer.

Variations in color and grain pattern are a natural characteristic of wood. Color changes also may result from exposure to light, heat, smoke, household cleaners, and other elements and environmental conditions that are part of the aging process. These material variations and changes are not covered by this warranty. Wolf Home Products reserves the right to substitute for discontinued product the most similar product in styling, wood species and color available at the time a claim is submitted.

Paint finishes are uniquely different from standard wood finishes. On all wood products, expansion and contraction are typical due to changes in climate conditions. Due to this normal movement, paint finishes may develop slight separation lines, finish breaks and seam lines. With use of selected hardwoods and veneers, some grain patterns and wood characteristics (checks, pin knots) as well as seams and joints will remain visible through the paint finish. Over time, there may be a slight color shift, due to exposure to natural and artificial light. These normal conditions are not considered quality defects and are not covered by this warranty.

THIS WARRANTY IS THE EXCLUSIVE WARRANTY OF WOLF HOME PRODUCTS AND IS IN LIEU OF AND WOLF HOME PRODUCTS DISCLAIMS ALL OTHER WARRANTIES, EXPRESS OR IMPLIED, INCLUDING THE IMPLIED WARRANTIES OF MERCHANTABILITY AND FITNESS FOR A PARTICULAR PURPOSE. Some states do not allow the exclusion or limitation of incidental or consequential damages, so the above limitations or exclusions may not apply to you. This warranty gives you specific legal rights and you may also have other rights that vary from state to state.

To submit a claim under this warranty, contact your nearest Wolf Classic cabinets dealer or send a letter explaining the defect along with photos and a dated sales receipt as proof of purchase to the address below.

**Wolf Classic Cabinets**  
**Attn: Warranty Claims**  
**20 West Market Street**  
**York, PA 17401**  
**800-234-9653**  
**fax: 717-792-4052**  
**KBCSWarehouse@wolfhomeproducts.com**



Wolf strives to ensure all pricing and specifications are accurate. However, in instances where there are discrepancies between 20/20 and the list pricing and product specification guide, use the current guide as the rule. If you are in doubt about any pricing or specifications please contact your Wolf Sales Consultant or Wolf Customer Care.













TRANSFORMING  
HOMES FOR OVER

175  
— YEARS —

Wolf Home Products® is an innovator in the building products industry. Transforming homes for more than 175 years, Wolf Home Products has been the preferred home building products brand by families across North America who value the importance of their home and time together to build lasting memories in the spaces they enjoy most. With a vast inventory of kitchen and bath, outdoor living and building products, Wolf Home Products delivers orders in a fraction of the time, ensuring unparalleled value when and where customers need it. Wolf stands behind its service, cultivated with years of business experience into a total satisfaction guarantee.



Find us on Instagram @**wolfhomeproducts**  
for inspiration on your next project!



Kitchen & Bath



Outdoor Living



Building Products

[wolfhomeproducts.com](https://www.wolfhomeproducts.com) | © 2023 Wolf Home Products. All Rights Reserved.

All photos are representative of product. Please review an actual product sample with your dealer before making your final selection. Information contained within is subject to change without notice.

